

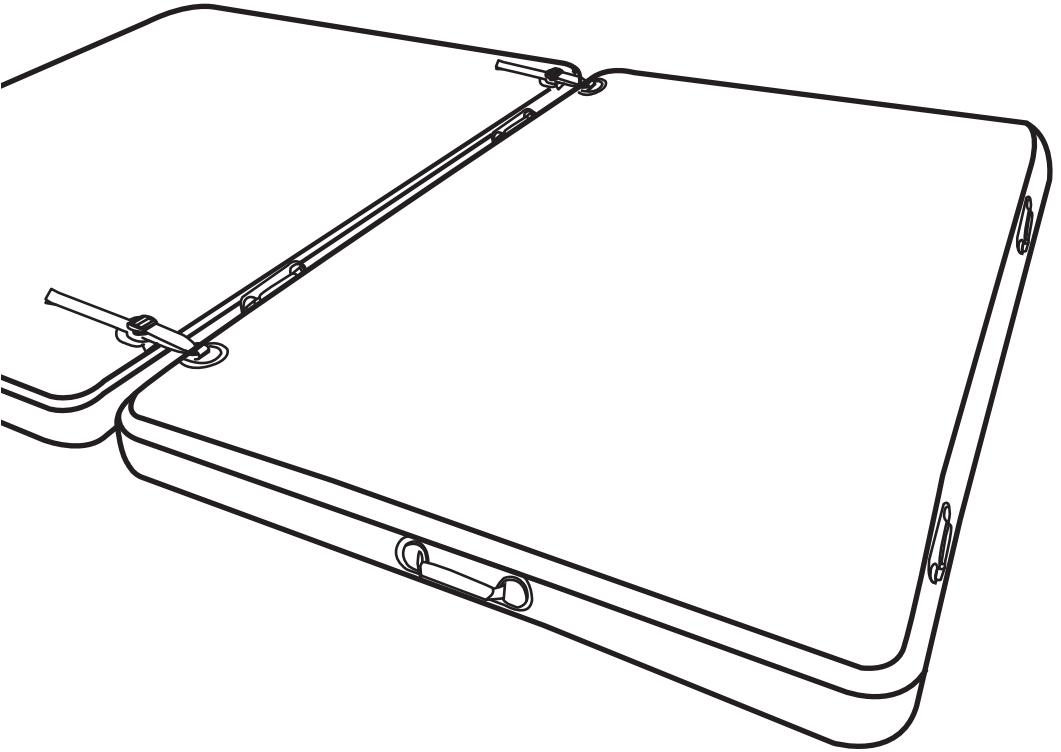

AQUA MARINA

EN



INFLATABLE AIR PLATFORM

User's Guide

www.aquamarina.com





WARNING

For your own safety and that of your equipment, make sure to take the following precautions. Failure to follow warning notices and instruction may result in property damage, serious injury or death.

WATERSPORTS SAFETY CODE

Watersports are fun and challenging but involve inherent risks of injury or death. To increase your enjoyment of the sport and to reduce your risks, use common sense and follow these rules:

Before you start

- Familiarize yourself with all applicable federal, state, and local laws, the risks, inherent in the sport, and the proper use of the equipment.
- Know the waterways.
- Use caution and common sense.
- Do not attempt or allow somersaults. Landing on the head or neck can cause serious injury, paralysis or death.
- Take extreme care when swimming between the shore and the product. Be cautious of any boat traffic or other obstructions. Ensure all users are capable swimmers and are not excessively fatigued.
- Always ensure that the swimming area around the air platform is free of submerged logs, rocks and sandbars. Ask about the local water conditions before use.
- Do not use without proper anchoring.
- Do not dive head first or swim under this product.
- Never use at night, or in low-light conditions.
- Never use in poor weather conditions with excessive wind, waves or lightning.
- Only allow use of the product with proper supervision. Secure the product when not in use to prevent access by any other users.
- Do not jump or dive from this item.
- Do not jump onto this item from any other item.
- Always remove personal items such as rings, watches or other sharp objects before use.

Your equipment

- Check all equipment prior to use. Inspect your product for missing, defective or worn parts.
- Always check for proper inflation before each use. Temperature and environmental changes can cause changes in tube pressure. Using the product over or under inflated is dangerous and can cause damage to the product, voiding the warranty.
- Always check security of the anchor and all attachments before each use.
- Always wear a life vest (PFD) as required by the authorities in area of use.

THE WARNINGS AND PRACTICES SET FORTH ABOVE IN THE WATERSPORTS SAFETY CODE REPRESENT SOME COMMON RISKS ENCOUNTERED BY USERS. THE CODE DOES NOT PURPORT TO COVER ALL INSTANCES OF RISK OR DANGER. PLEASE USE COMMON SENSE AND GOOD JUDGMENT.

SPECIFICATIONS

| MODEL | SIZE | VOLUME | MAX. RIDER WGT | MAX. AIR PRESSURE |
|----------------------------|-------------------------------------|--------|------------------|-------------------|
| ISLAND BT-I250 | 8'2" x 63" x 6" 250 x 160 x 15cm | 560 L | 584 lbs / 265 kg | 8 PSI |
| ISLAND+ BT-I250P | 8'2" x 63" x 6" 250 x 160 x 15cm | 560 L | 584 lbs / 265 kg | 8 PSI |

ACCESSORIES

STANDARD

Carry Bag

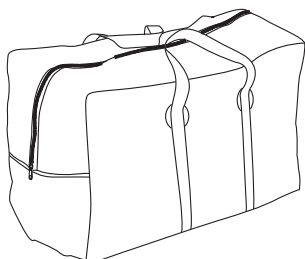

Double-Action Pump -
LIQUID AIR V1

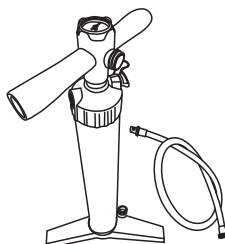

Connection Strap



WARNINGS AND CAUTIONS

NO PROTECTION AGAINST DROWNING
 AUCUNE PROTECTION CONTRE LA NOYADE
 KEIN SCHUTZ GEGEN ERTRINKEN
 SIN PROTECCIÓN CONTRA EL AHOGAMIENTO

8psi / 0.55bar

SWIMMERS ONLY
 LES NAGEURS SEULEMENT
 NUR FÜR SCHWIMMER
 SÓLO LOS NADADORES

INSTRUCTION FOR ASSEMBLING AND DISASSEMBLING

1. Unfold the Air Platform

Get yourself a clean and flat area to unfold the Aqua Marina air platform and lay it flat. In most cases, you will need at least 9 m² to inflate the air platform.

IMPORTANT: Careful thought must be given to the setup area regarding the size of the product. Ideally, this air platform should be carefully carried to and inflated at somewhere close to the water.

NOTE: Dragging or sliding the air platform on the ground, either before or after inflation, can cause damage.

2. Instruction for Assembling and Disassembling

A

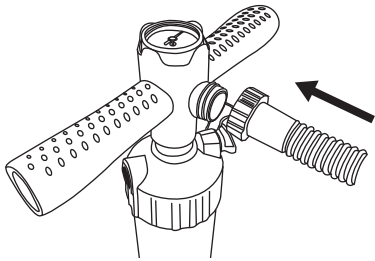

Pump Set Up And Inflation

Connect the pump hose to the gauge housing and secure it tightly.

B

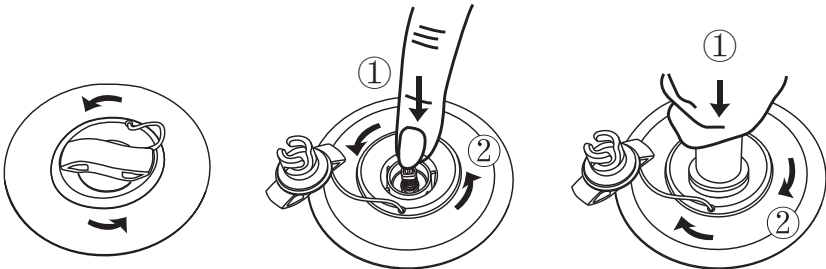

Inflation

- 1) Open the valve cap by twisting counter-clockwise. Ensure the valve is clear from debris, sand, or dirt before releasing.
- 2) Push valve button in and turn counter-clockwise 90 degrees so it pops up and is in the "OUT" position.
- 3) Insert the pump hose and twist it 45 degree clockwise to lock in place. Inflate until you reach the required pressure.

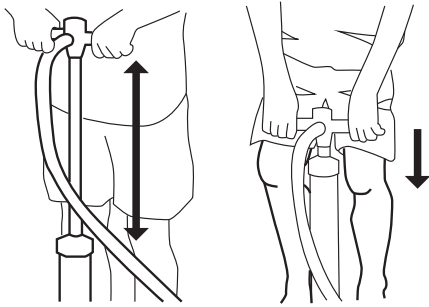

Inflate Faster With Less Effort

- Use full range of the pump cylinder while keeping your arms extended.
- Bend your knees and use the body weight.

C

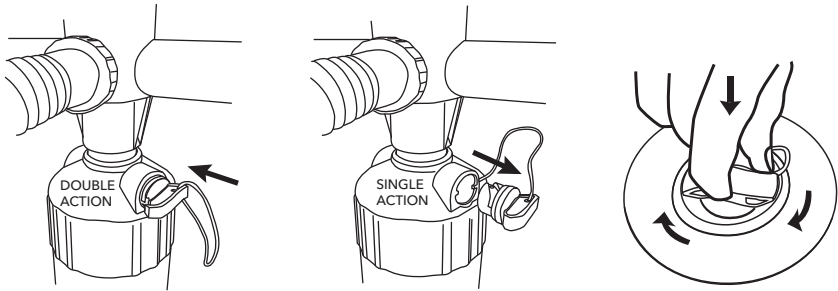

- 1) The pump can be switched between double action mode and single action mode.
- 2) After inflation, return the valve cover and tighten in clockwise direction to lock in place.



WARNING

DO NOT OVER INFLATE BEYOND 8PSI (0.55BAR). THIS WILL VOID YOUR WARRANTY.

D

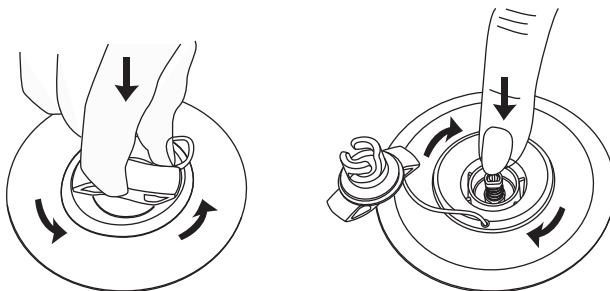

Deflation

To deflate your board, follow the instructions below.

- 1) Open the valve cap by twisting counter-clockwise. Ensure the valve is clear from debris, sand, or dirt before releasing.
- 2) Push valve button in and turn clockwise to lock it in DOWN position.

E Folding Steps

For ISLAND (BT-I250)

- 1) Completely deflate the ISLAND board by pushing out any remaining air, or use the pump on "deflate" position for faster deflation.
- 2) Tri-fold the board from the longer side.
- 3) Fold at one fourth of the length of the tri-folded board to the middle (refer to picture 3).
- 4) Fold in half.
- 5) The carry bag is designed to allow you to get your ISLAND into the bag as easily as possible with minimal folds.

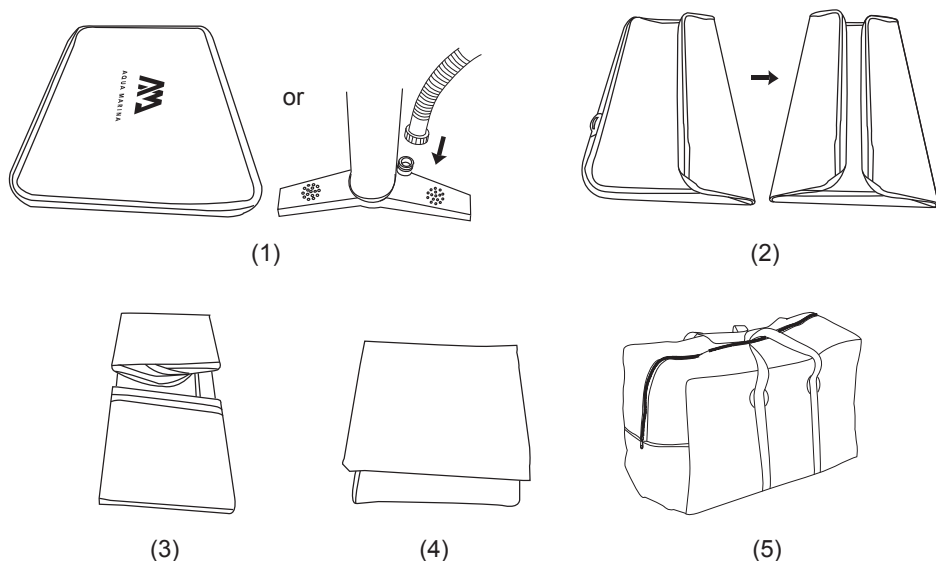

For ISLAND+ (BT-I250P)



To properly store ISLAND+ without damaging the EVA pad, please follow these steps:

- 1) Deflate the ISLAND+ board, or use the pump on "deflate" position for faster deflation.
- 2) Roll up the ISLAND+ board from the shorter side to the end.
- 3) Push out any remaining air as you roll.
- 4) The carry bag is designed to allow you to get your ISLAND+ into the bag as easily as possible.

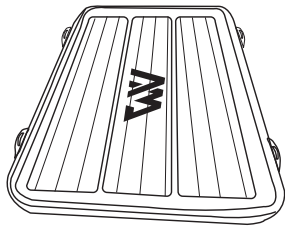

(1)

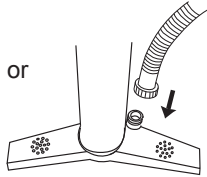

or

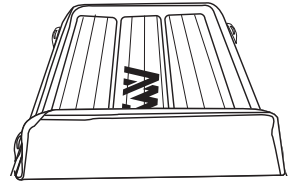

(2)

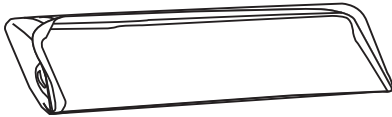

(3)

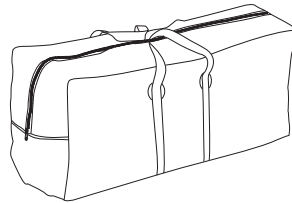

(4)

3. Inflation Tips and Precautions

- The platform can be inflated either with our hand pump or an electric pump. Electric Pumps can be used to inflate the platform up to 80-90% of the required air pressure. However, the remaining pressure required should be reached by using our hand pump to avoid over-inflation.
- Do NOT over-inflate the platform. A max pressure of 8psi is adequate.
- Do NOT use an air compressor. Damage to your air platform caused by over inflation from an air compressor is not covered by your warranty.
- If leaving the platform inflated, we strongly recommend you to keep it under shade from direct sunlight, and deflate the platform at least to 5PSI.
- After 2 or 3 days, there may be a slight decrease of pressure due to temperature change. If so, add a few pumps of air.
- Do NOT pump the platform to a high pressure and leave it in the sun. If the platform is going to be in a warm environment, slightly under-inflate it.
- Low water temperature may cause a slight loss in chamber pressure. You are recommended to carry a pump with you to add some air when necessary.

WARNING:

NEVER DRAG THE AIR PLATFORM! YOU MUST LIFT AND SET THE PRODUCT ON THE WATER TO AVOID ANY ACCIDENTAL TEARING ON SHARP OBJECTS.

OPERATION

- 1) This item is an inflatable air platform designed to be used on the water.
- 2) Two separate air platforms could be connected by using the straps (come with the package) to connect the built-in D-rings on the board, as shown in the picture (FIG.1). Make sure that the connection is tight and there is NO gap greater than 25mm (3/4") between the platforms.

IMPORTANT: Failure to properly connect the platforms may result in injury or death.

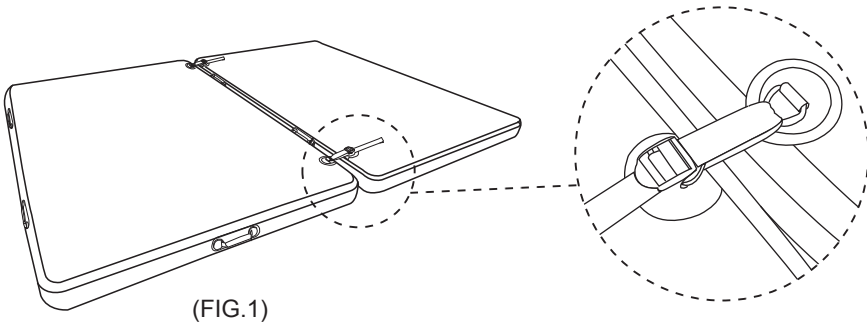

- 3) Do not jump or dive from the product.
- 4) Do not jump onto this product from another. Unexpected motion may cause a loss of balance and injury.
- 5) Do not swim underneath the air platform.
- 6) The maximum weight capacity is 265 kg (584 lbs). It is acceptable to have up to four (3adults + 1 child) people on the platform.
- 7) Do not use the air platform when connected with moving vessels.

IMPORTANT:

- DO NOT use without adequate air pressure – 6psi (0.41bar) minimum.
- DO NOT over inflate - 8psi (0.55bar) maximum.

HOW TO FIX A LEAKING VALVE

1. Try to tighten the valve

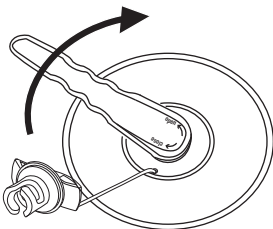

- 1) Inflate your platform up to the max air pressure, 8PSI.
- 2) Stick your valve wrench down inside of valve and turn clockwise to tighten the valve back down onto the platform.

2. Re-install or replace a valve

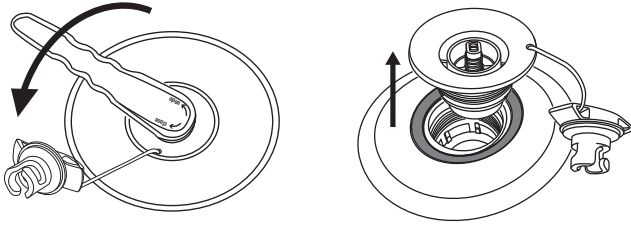

- 1) Completely deflate your platform.
- 2) Undo the dust cap and insert the valve wrench into the valve and twist counterclockwise to remove the valve.

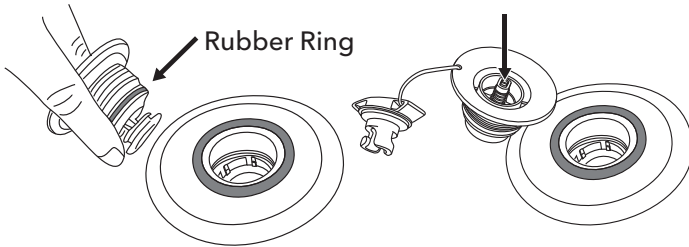

- 3) Check the rubber ring to make sure that it is in the correct position, tight around the valve and there is no debris in the way.
- 4) Be sure the pin spring is functioning properly and there are no cracks along the edges.

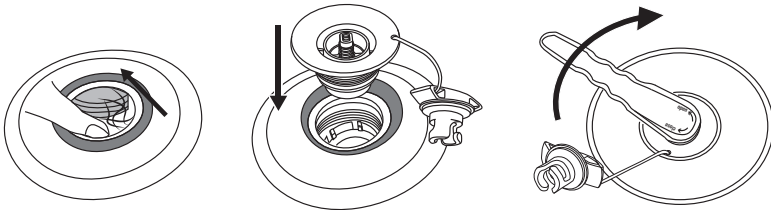

- 5) Ensure there are no strings from the drop-stitch material.
- 6) Note the bottom piece of the valve is not attached to anything.
- 7) Fit the valve back into your platform.
- 8) Align all the threads and twist to tighten.
- 9) Once the valve is hand tight, use the valve wrench to seal completely.



NOTE: Correctly use the wrench by pressing it with one hand on top.

LEAK DETECTION AND REPAIR

About PVC

Your new platform is made from a durable double stitch PVC. If a tear or puncture does occur, PVC is very easy to repair. Repairs are easily done with your included patch kit. Read the following paragraphs for leak detection and repair tips.

Air Leak Detection

If your platform is losing air pressure, not caused by colder temperatures, check the platform for leaks, starting with the valve. A leaking valve is rare, but if you do find a leak we can send you a replacement valve. To locate a leak, we recommend mixing soap and water in a spray bottle, spray around the valve. If you see bubbles forming, check your valve seating and base and be sure the valve insert is screwed tightly. If you continue to have problems it's probably time to order a new valve. Replacement of the whole valve can be done with a simple tool that comes with the replacement valve.

If the platform is losing air and the valve is good, you probably have a small puncture. Small punctures can be repaired easily and permanently. Spray around the platform until air bubbles become visible and mark the position of the leak. If you do not find air bubbles, inflate the air platform to maximum air pressure and try to listen to find the leak. If you can narrow the area down, return with a spray bottle to identify the source of the leak.

Punctures less than 1/8" in size can be repaired simply without a patch. Deflate your platform, then clean and dry the area to be repaired. Apply a small drop of glue to cover the puncture, and let dry 12 hours.

Small Repairs

Your platform comes with a repair kit as standard equipment. If you no longer have your repair kit, you can order a new one from your dealer. Cut a piece of repair material large enough to overlap the damaged area by approximately 1.5cm (1/2"), and round off the edges. Apply glue to the under side of the patch and around the area to be repaired. Too much glue will interfere with a proper repair. Allow adhesive to become tacky for 2-4 minutes, and then starting at one corner and working outward, carefully apply the patch to the repair area using very firm pressure. Rub the entire patch area and the edges of the patch using very firm pressure. Allow to cure for at least 12 hours before inflating and using.

WARRANTY

Aqua Marina warrants this product to be free from major defects in material or workmanship to the original purchaser for a period of one (1) year from the date of purchase. This warranty is subject to the following limitations.

1. The warranty is valid only when this product is used for normal recreational activities and does not cover products used in rental or school operations.
2. Aqua Marina will make the final warranty determination, which may require inspection and/or photos of the equipment, which clearly show the defect(s). If necessary, this information must be sent to the Aqua Marina distributor in your country with prepaid postage. Product can be returned only if a return authorization number is given in advance by the Aqua Marina distributor. The return authorization number must be clearly labeled on the outside of the package, or it will be refused.
3. If a product is deemed to be defective by Aqua Marina, the warranty covers the repair or replacement of the defective product only. Aqua Marina will not be responsible for any costs, losses, or damages incurred as a result of loss or misuse of this product.
4. This warranty does not cover damage caused by misuse, abuse, neglect, normal wear and tear including, but not limited to, punctures, damage due to excessive heat exposure, damage caused by improper handling and storage, damage caused by use in waves or shore break, board breakage caused by filling or crashing in surf conditions, or damage caused by anything other than defects in material and workmanship.
5. This product must not be used in excess of the manufacturers recommended maximum load capacity.
6. This warranty is void if any unauthorized repair, change or modification has been made to any part of the equipment.
7. The warranty for any repaired or replacement equipment is available from the date of the original purchase only.
8. The original purchase receipt must accompany all warranty claims. The name of the retailer and date of purchase must be clear and legible.
9. There are no warranties that extend beyond the warranty specified here in.



WARNING

THIS PRODUCT IS DESIGNED IN ACCORDANCE WITH STANDARDS FOR A SPECIFIC USE. ANY MODIFICATIONS OR TRANSFORMATIONS HIGHER THAN THAT INDICATED BY THE MANUFACTURER COULD RESULT IN SERIOUS RISKS FOR THE USER AND WILL VOID THE WARRANTY.